

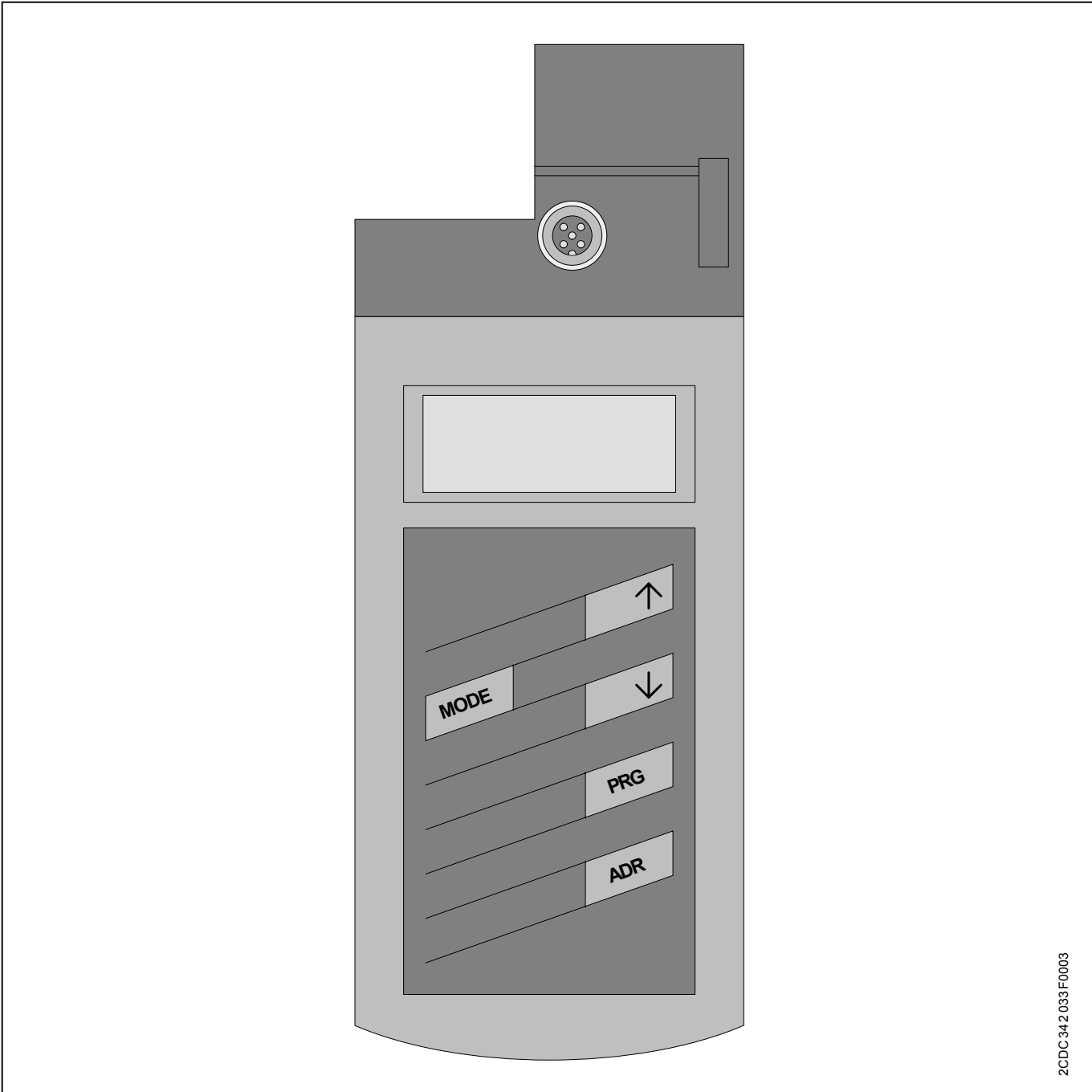

V6

Addressing Device  
ASA21-FBP



2CDC342 033 F0003







**Addressing Device ASA21-FBP to adjust the slave address into an AS-Interface-FieldBusPlug**

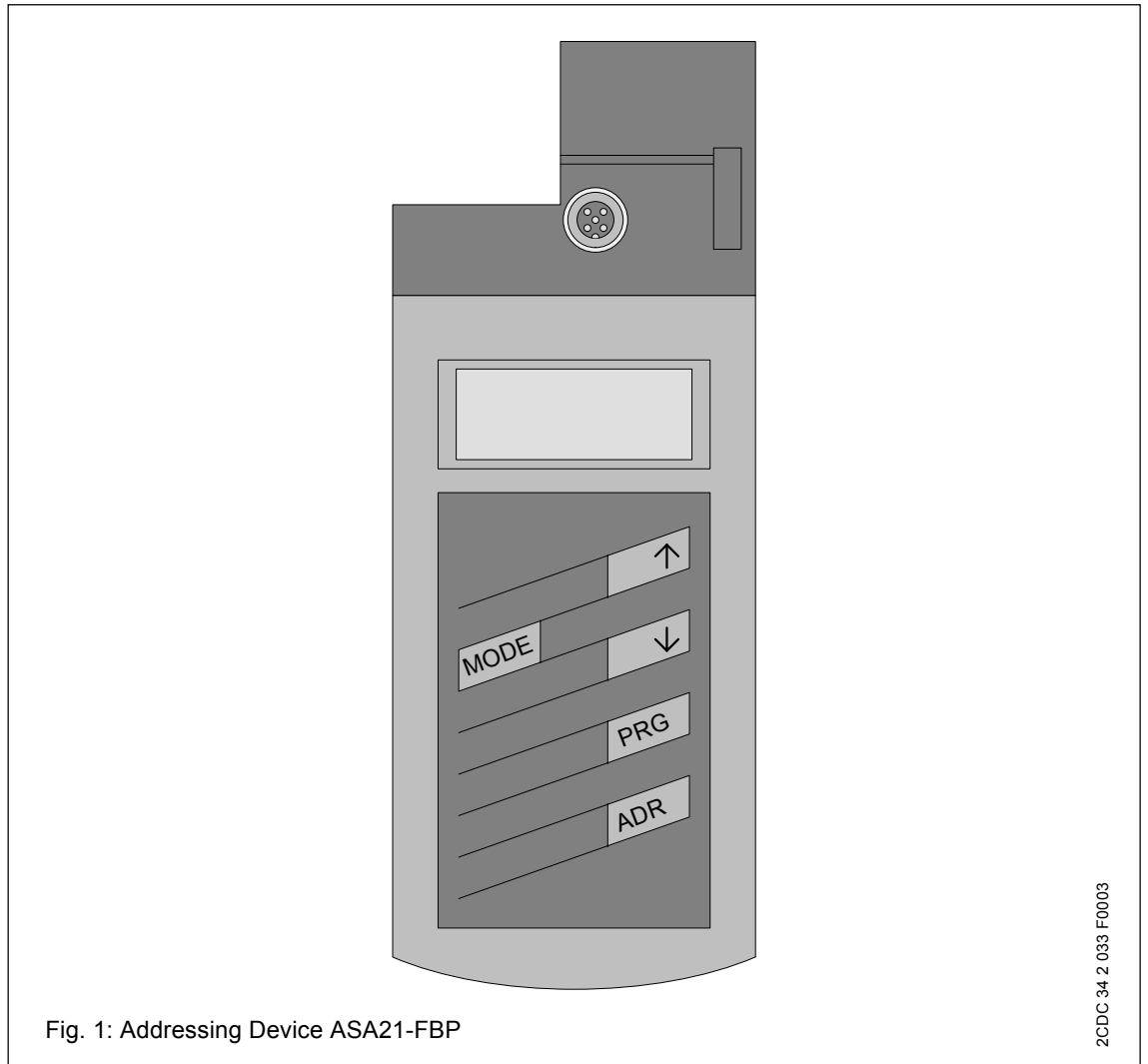

Fig. 1: Addressing Device ASA21-FBP

2CDC 34 2 033 F0003

<b>Contents</b>	<b>Page</b>
Overview .....	4
Start-up .....	5
Address setting	
- Basics .....	6
- Address setting of an AS-Interface FieldBusPlug only with the Addressing Device .....	6
- Address setting of several AS-Interface FieldBusPlugs at the same time only with the Addressing Device .....	7
- Address setting of an AS-Interface FieldBusPlug with an additional infrared adaptor .....	7
Error messages .....	9
Technical data .....	10



**Overview**

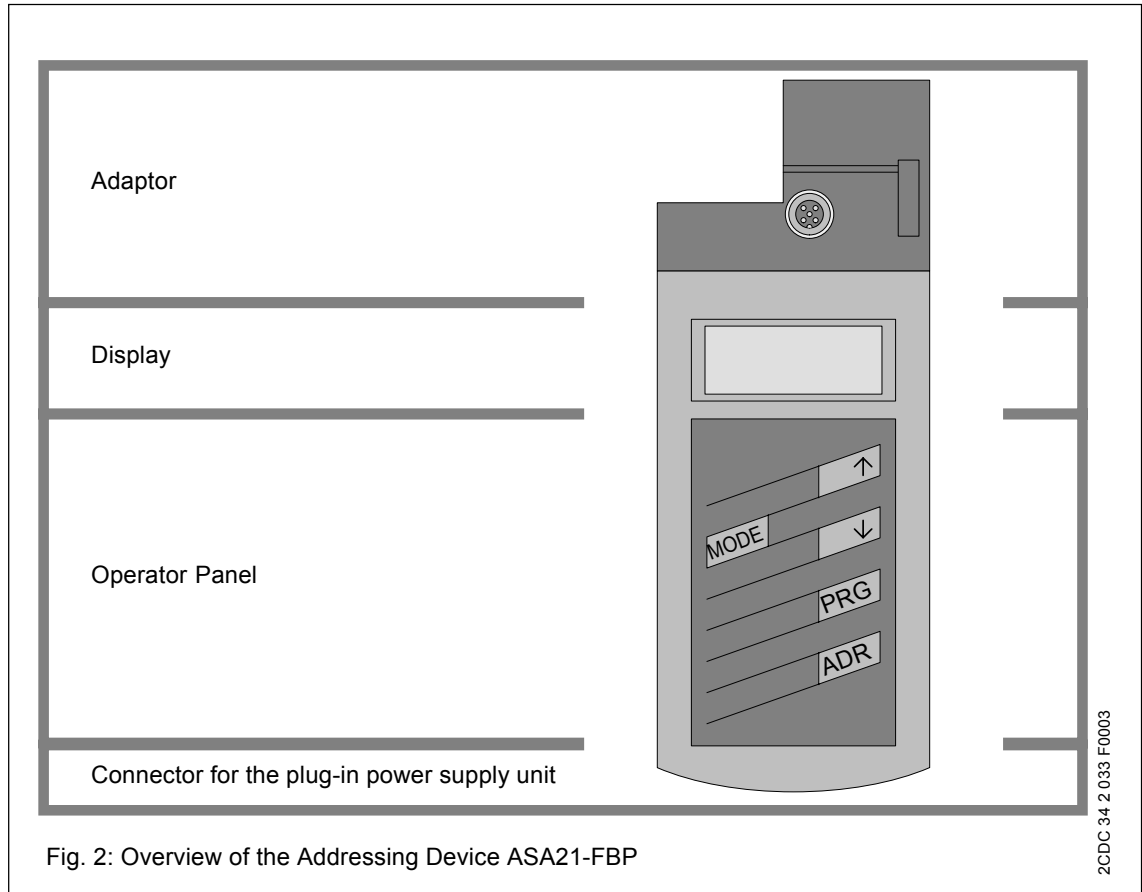

Fig. 2: Overview of the Addressing Device ASA21-FBP

**Adaptor**

The adaptor is used to connect the AS-Interface FieldBusPlugs to the Addressing Device. The AS-Interface FieldBusPlug can be connected directly or over an infrared adapter.

**Display**

All connected available AS-Interface FieldBusPlugs are displayed in the LC-Display. The display is divided into the following areas:

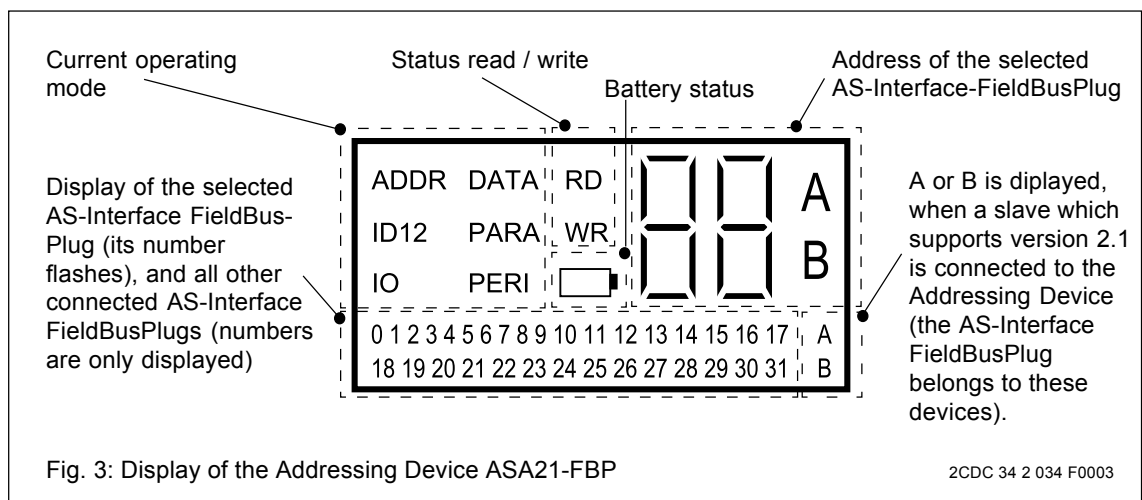

Fig. 3: Display of the Addressing Device ASA21-FBP



### Control panel

With the control panel, an AS-Interface FieldBusPlug can be selected to change its address.

#### Buttons and their functions:

- |      |                                                                                                                                                                                                                        |
|------|------------------------------------------------------------------------------------------------------------------------------------------------------------------------------------------------------------------------|
| ADR  | - switch on the Addressing Device<br>- search for all connected AS-Interface FieldBusPlugs<br>- activate the AS-Interface FieldBusPlug with the next higher address<br>- update the display after changing the address |
| PRG  | - save the new address into the AS-Interface FieldBusPlug                                                                                                                                                              |
| MODE | - set operating mode                                                                                                                                                                                                   |
| ↑    | - set the desired address (counting upward)                                                                                                                                                                            |
| ↓    | - set the desired address (counting downward)                                                                                                                                                                          |

### Connector for the plug-in power supply unit

At the bottom of the Addressing Device there is a socket contact to connect the plug-in power supply unit (included in the scope of delivery), to charge the build-in battery. When the battery symbol  lights up, the battery needs to be recharged for at least 24 hours .

### Start-up

The Addressing Device should be charged by with the provided plug-in power supply unit for at least 24 hours before its first use. To do this, the plug-in power supply unit has to be connected to the socket at the bottom of the Addressing Device (see figure 4). It is not possible to overload the battery.

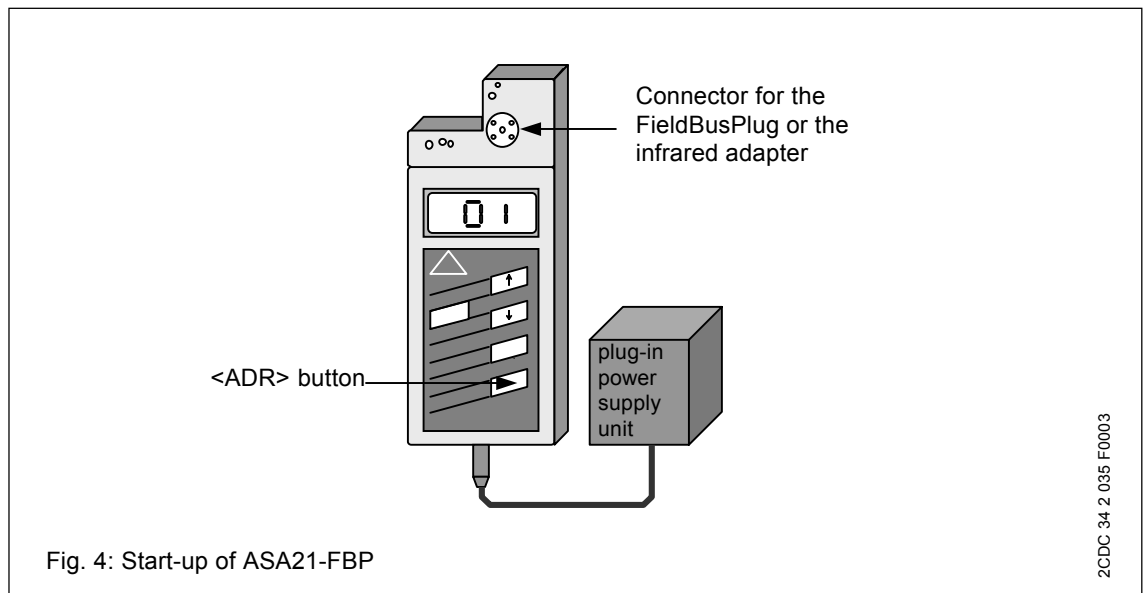

When the battery is charged, switch on the Addressing Device by pressing the <ADR> button.



## Address setting

### Basics

The AS-Interface FieldBusPlugs have the default address 0A. This is an invalid address. A valid address has to be set.

According to the extended AS-Interface standard, 62 different addresses can be set. They are divided into the addresses 1A to 31A and 1B to 31B, if the AS-Interface master (coupler, gateway, etc.) supports this kind of addressing. Otherwise only the addresses 1 to 31 are available, which have to be set as 1A to 31A to the AS-Interface FieldBusPlug.

Pay attention that all slaves, which are to be connected to the same fieldbus, have different addresses.

### Address setting of an AS-Interface FieldBusPlug only with the Addressing Device

The AS-Interface FieldBusPlugs are normally connected to the Addressing Device separately from each other to set their addresses (see figure 5).

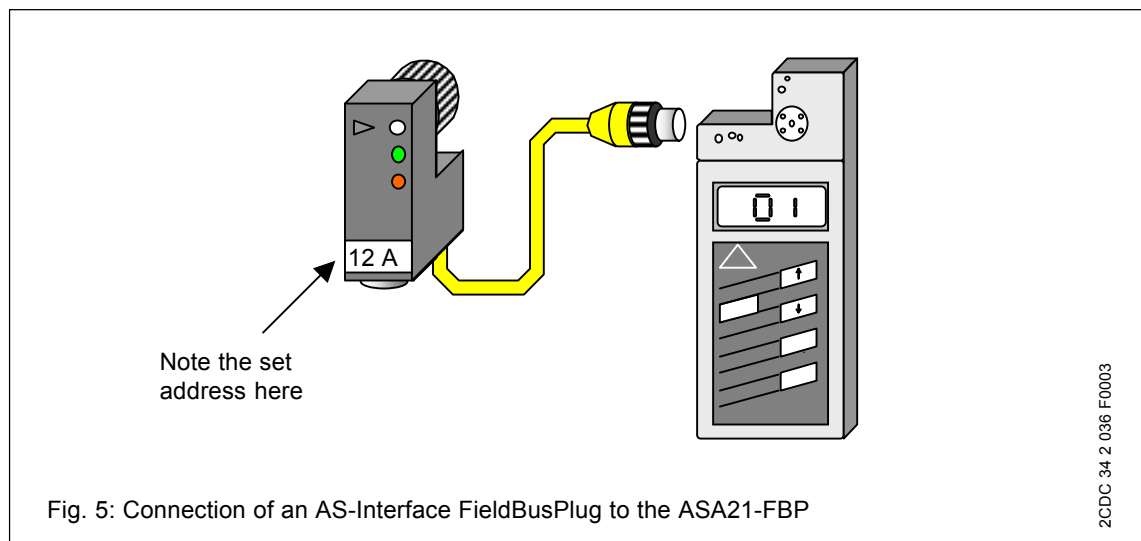

Fig. 5: Connection of an AS-Interface FieldBusPlug to the ASA21-FBP

After switching on the Addressing Device, it is automatically in addressing mode. This is indicated by display 'ADDR'. If an other mode is displayed, press <MODE> button as far as 'ADDR' is displayed. Pressing the <MODE> button for a longer time also sets the Addressing Device to addressing mode.

### Remark:

If the error message F2 appears, the Addressing Device could not recognize any AS-Interface FieldBusPlug.

In the addressing mode, the address of the AS-Interface FieldBusPlug is displayed on the top right of the display. The display 'RD' lights up. The current address can be changed with the buttons ↑ and ↓ between 1A and 31B. By pressing the <PROG> button, the new address is stored into the AS-Interface FieldBusPlug. This is indicated by displaying 'WR'. Press the <ADR> button to update the display.

When there is no action for more than a minute, the Addressing Device switches off automatically, to conserve the battery's energy.





#### Address setting of several AS-Interface FieldBusPlugs at the same time only with the Addressing Device

You have the possibility to check or change the addresses of several AS-Interface FieldBusPlugs which are interlinked. The following things are important:

- The number of the interlinked AS-Interface FieldBusPlugs, which are connected to the Addressing Device, is limited to about 5 because of their current consumptions. Error message F1 is displayed, when the current consumption is too high.
- The addresses of the interlinked AS-Interface FieldBusPlugs, which are connected to the Addressing Device, have to be different. Otherwise error message F4 is displayed.

#### Proceedings

In the addressing mode, all connected and recognized slaves are displayed in the lower part of the display. The address of one slave flashes with a frequency of 2 Hz. By pressing the **<ADR>** button, the AS-Interface FieldBusPlug with the next higher available address can be selected. If you connect slaves with A- or B-addresses to the Addressing Device, the display toggles between A and B addresses in intervals of 2 s.

The address of the selected AS-Interface FieldBusPlug can be changed as described in chapter 'Address setting of an AS-Interface FieldBusPlug only with the Addressing Device'.

#### Address setting of an AS-Interface FieldBusPlug with an additional infrared adaptor

In addition to the direct addressing you can also address the AS-Interface FieldBusPlug using the infrared interface of the AS-Interface FieldBusPlug. You need an extra infrared adaptor, which has to be plugged into the socket of the Addressing Device before addressing (see figure 6).

Before you can start to set the address to the AS-Interface FieldBusPlug via the infrared adaptor, you have to stop the data exchange between the bus master and the AS-Interface FieldBusPlugs. Switch the PLC-CPU to „Stop“ will not be enough in most cases.

For a proper use you have to guarantee, that the AS-Interface FieldBusPlugs are still supplied with 24 V, after disconnecting of the master. A lot of AS-Interface power supply units already have plug-in jumper (see figure 6), so that the bus devices are still supplied after disconnection of the AS-Interface coupler.

The infrared adaptor has to be plugged to the jut-out triangle of the AS-Interface FieldBusPlug as shown in figure 6.

After switching on the Addressing Device, it is automatically in the addressing mode. This is indicated by displaying **'ADDR'**. If an other mode is displayed, press the **<MODE>** button as far as **'ADDR'** is displayed again. Pressing the **<MODE>** button for a longer time also sets the Addressing Device to the addressing mode.



#### Remark:

If the error message F2 appears, the Addressing Device could not recognize any AS-Interface FieldBusPlug.

In the addressing mode, the address of the AS-Interface FieldBusPlug is displayed on the top right of the display. The display **'RD'** lights up. The current address can be changed with the buttons **↑** and **↓** between 1A and 31B. By pressing the **<PROG>** button, the new address is stored into the AS-Interface FieldBusPlug. This is indicated by displaying **'WR'**. Press the **<ADR>** button to update the display.

After the address setting has been finished, the communication to the bus master must be established again.

When there is no action for more than a minute, the Addressing Device switches off automatically, to conserve the battery's energy.



# Addressing Device ASA21-FBP Technical Description

V 6

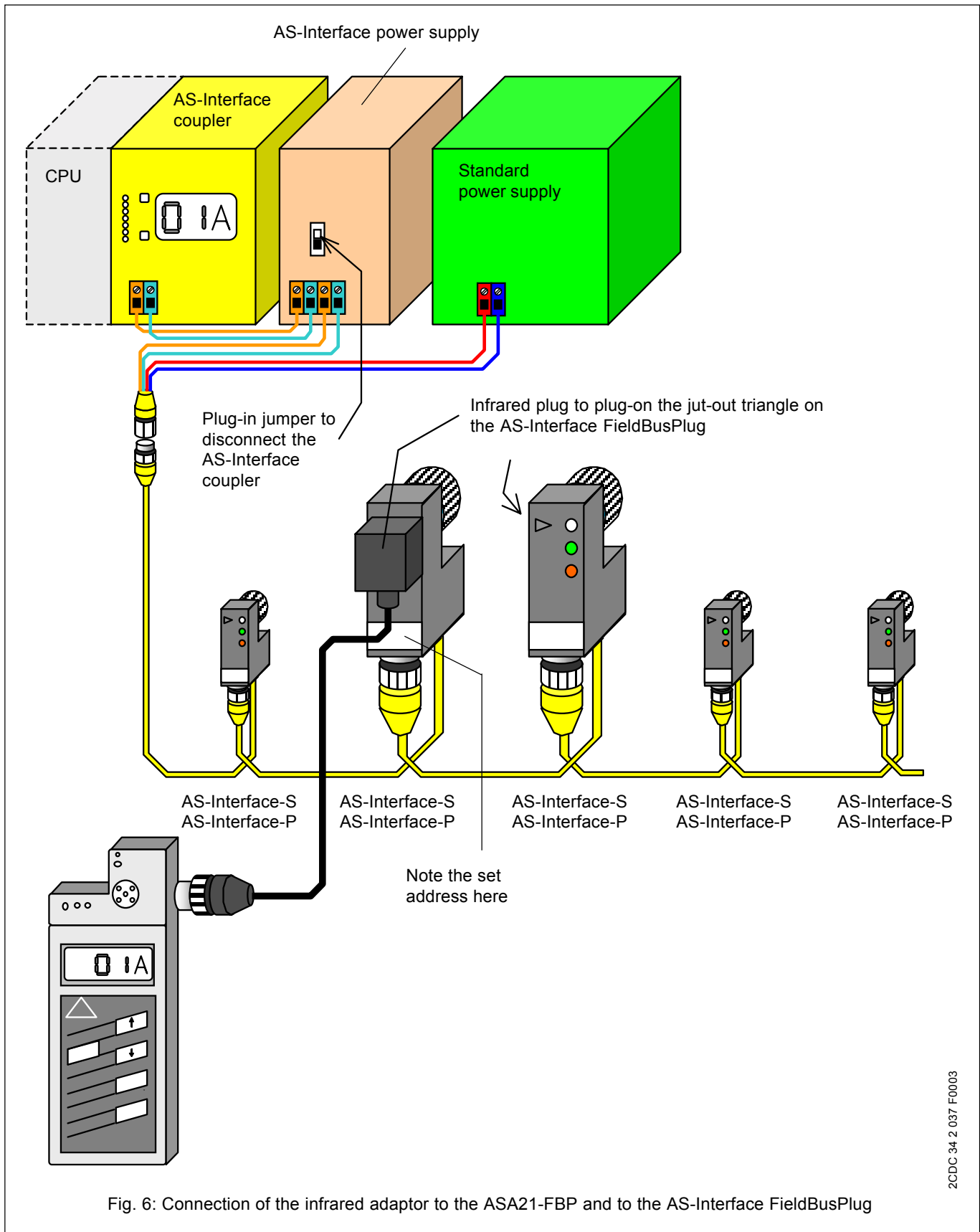

2CDC 34 2 037 F0003

**Error messages****F1 Overload at the AS-Interface**

The current consumption of the AS-Interface FieldBusPlugs, which are connected to the Addressing Device, is too high, that means, the Addressing Device can not deliver enough current to supply all connected plugs. You can help yourself by connecting an AS-Interface power supply unit.

**F2 No AS-Interface FieldBusPlug found****F3 Programming error**

The address value could not be saved completely into the AS-Interface FieldBusPlug.

**F4 Target address already used**

The target address for the activated AS-Interface FieldBusPlug is already used.

**F7 Extended slave instead of standard slave found**

The error message F7 is shown, when you try to set a conventional address (A or B are not displayed) to an AS-Interface FieldBusPlug (slave of version 2.1).

**F8 Reception error**

The correct reception of the slave address failed.

**LOBAT Battery is exhausted**

After the first display, about 30 read or write actions are still possible. Recharge the battery only with the provided plug-in power supply unit.



# Addressing Device ASA21-FBP Technical Description

V 6

## Technical data

### General data

Accessories plug-in power supply unit 230 V AC (included in the scope of delivery)

### Application range

FieldBusPlugs for AS-Interface	ASD11-FBP.025	ASP22-FBP.025
	ASD11-FBP.050	ASP22-FBP.050
	ASD11-FBP.100	ASP22-FBP.100
	ASD11-FBP.500	ASP22-FBP.500

### Interface

Type of interface AS-Interface, short-circuit- and overload-proof

### Display / Operating elements

Display	LC-Display
Keyboard	membran keyboard with 5 buttons

### Electrical data

Operating time	8 hours or 250 read/write functions, if the battery is completely charged
Power supply	battery supply

### Environmental operating conditions

Ambient temperature	0 ... 55°C
Storage temperature	-20 ... 55°C

### Mechanical data

Degree of protection	IP20 according to EN 60529
Dimensions (W x H x D)	80 x 214 x 34 mm
Weight	about 275 g

### Ordering details

Addressing Device ASA21-FBP.0	Order code: 1SAJ 922 010 R0001
Included in the scope of delivery	Addressing Device, plug-in power supply unit





---

**ABB STOTZ-KONTAKT GmbH**

Eppelheimer Straße 82 Postfach 101680  
69123 Heidelberg 69006 Heidelberg  
Germany Germany

Telephone +49 6221 701-0  
Telefax +49 6221 701-240  
E-Mail [desst.help@de.abb.com](mailto:desst.help@de.abb.com)  
Internet <http://www.abb.de/stotz-kontakt>